

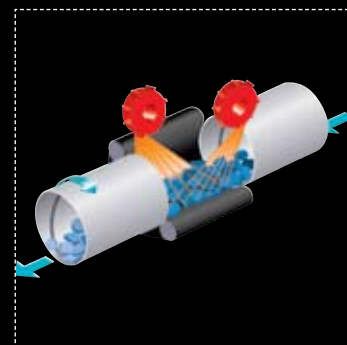

# CT Through-feed blast cleaning machine

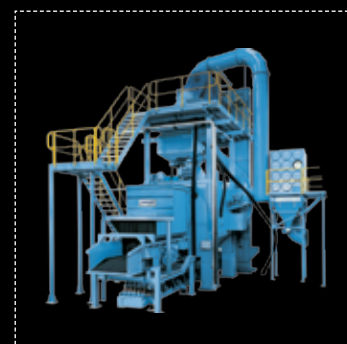
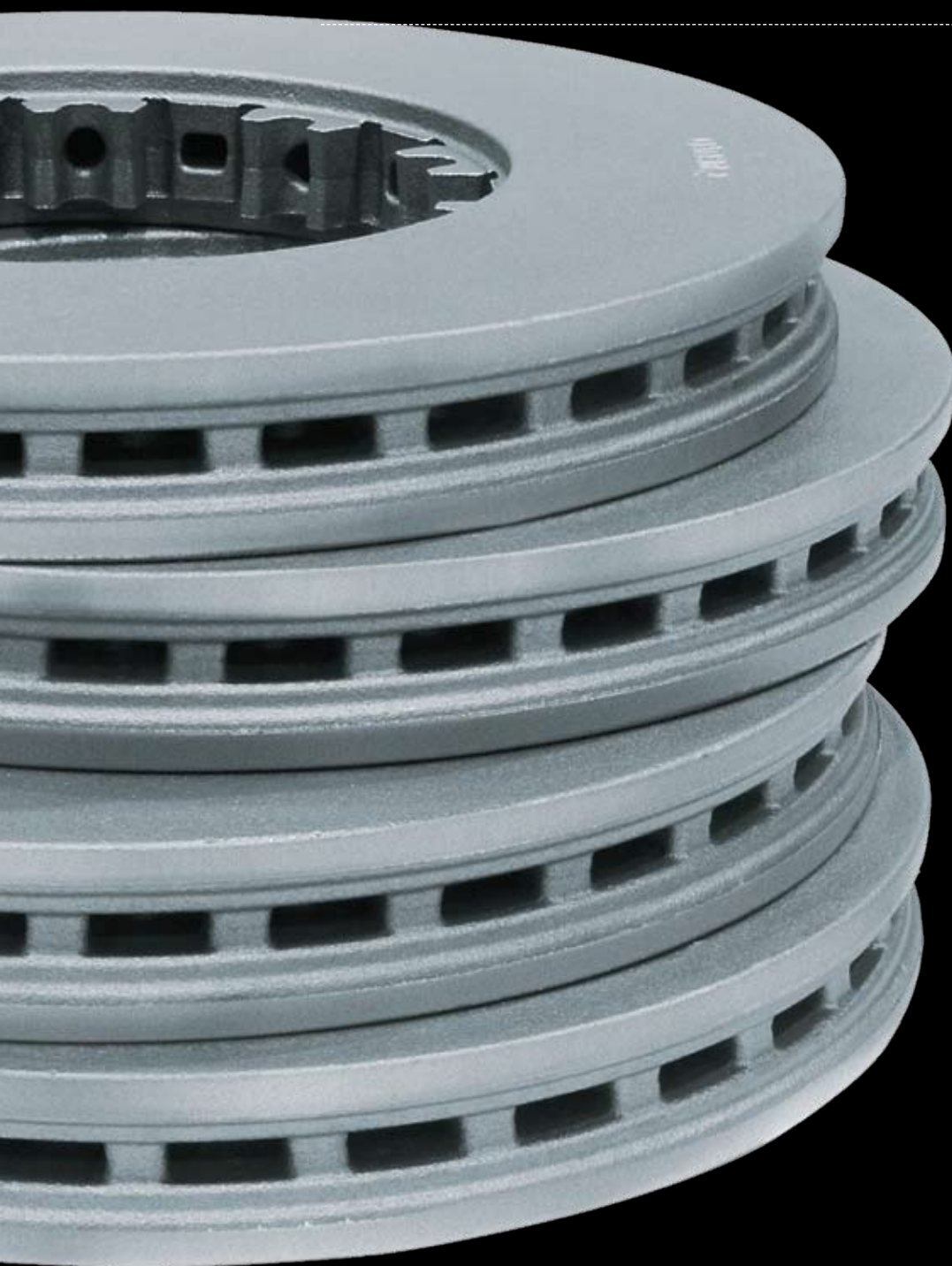

wheelabrator  
shaping industry

---

# CT Through-feed blast machine

---

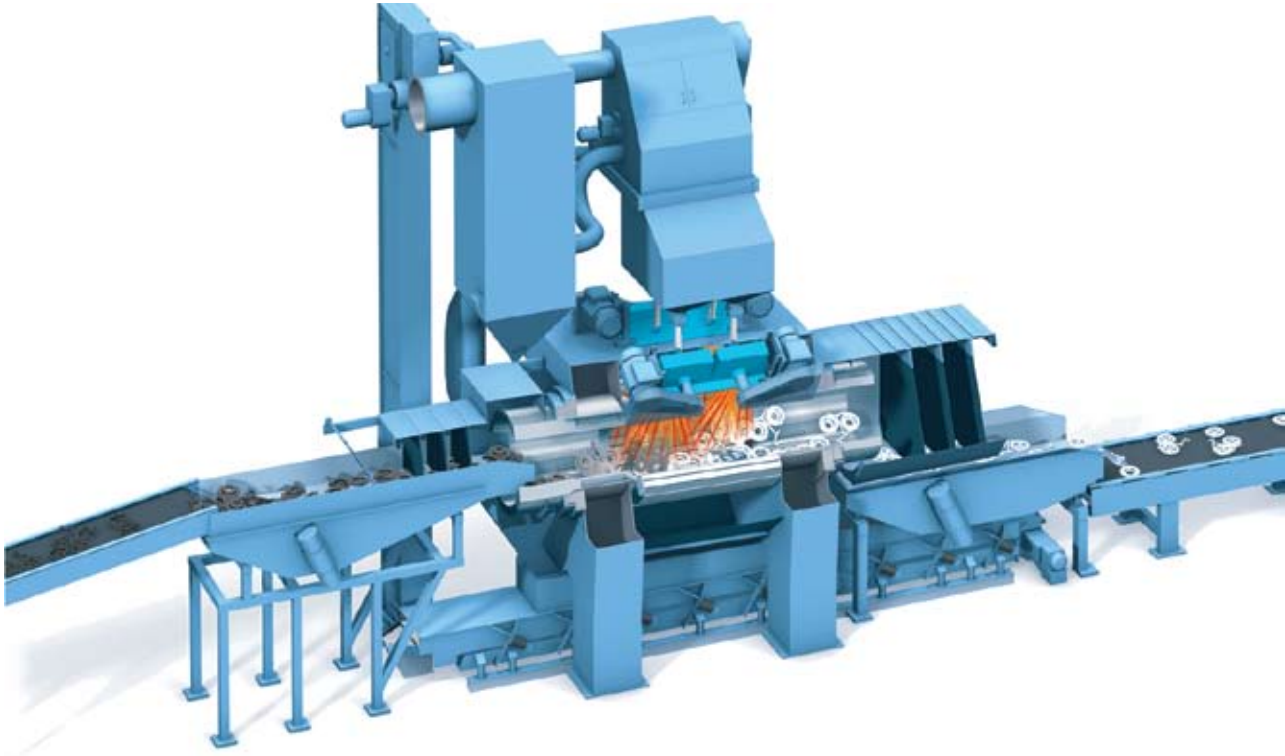

## Automatic, continuous and dust-free blast cleaning

The through-feed blast cleaning process offers a number of distinct advantages and ensures efficient and cost effective blast cleaning. Continuous shot blast machines automate production sequences and improve the work environment. Main advantages:

- A fully automatic production flow from the moulding line to the finishing department
- Clearly arranged production processes, improved production consistency
- Short transport distances without intermediate stocking
- Reduced operating costs, as the blast cleaning process can be integrated in an automatic production line
- Minimal floor space requirement
- Little or no need for manual handling of the uncleaned work-pieces. This will help improve operator environment and eradicate hazardous workplaces

Automatic manufacturing processes require highly flexible production systems to be able to cope with changing production requirements. Flexible systems can quickly adapt to changes in production rates, lot size, finishing techniques, and market demands.

Typical applications of CT Throughfeed blast cleaning machines include:

- Removing sand and cores from castings
- Descaling castings and forgings
- Handling mixed and single product runs
- Cleaning clusters
- Keeping the blast cleaning performance at a consistently high level, regardless of fluctuations in production rates.

CT blast cleaning machines are proven in hundreds of applications and offer the following benefits:

- High cleaning capacity, short blasting times
- Careful arrangement of blast wheels on the machine results in optimum utilisation of the abrasive energy
- Full exposure of all work-piece surfaces to the blast stream
- Automatic material flow control, optimal filling degree of barrel, automatic adaptation of abrasive throughput. This results in the best possible cleaning effect and minimal wear on machine components and abrasive.
- Easy maintenance set up
- Integration into existing production lines
- Leading technology, outstanding experience

# Blast wheel



Blast cleaning machine with inlet and outlet vibratory conveyors



Uncleaned castings in the inlet barrel



Parts in the outlet barrel after cleaning

## The blast wheels: Highly efficient and precise

Wheelabrator blast wheels are known for high capacity and maximum energy efficiency. They are available in different sizes to meet individual requirements. Due to the reversibility of the blast wheel rotation, the range of applications can be considerably extended.

The throwing power of the wheels and shot impact are fine-tuned to suit specific applications and to ensure optimal energy efficiency. The amount of abrasive can be adjusted from the operator's panel. The abrasive is mechanically pre-accelerated and delivered to the blast wheel in a continuous stream, fully utilising the drive power of the motors to achieve the best blast cleaning effect.

The careful arrangement of the blast wheels plus the ability to adjust the throwing angle of the abrasive, assure that work-pieces are always blast cleaned in the hot spot. Machine components within the throwing range of the blast wheels are made of highly wear-resistant material to avoid excessive wear.

- ① Wheel body
- ② Control cage
- ③ Impeller
- ④ Blade



---

# Principle and mode of operation

---

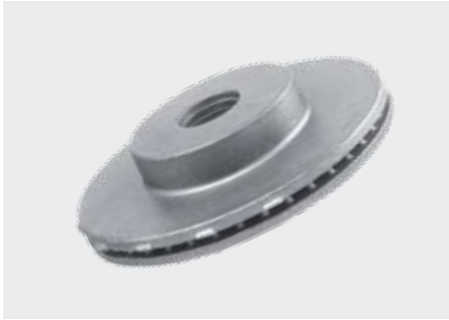

The blast cleaning installation is divided into three zones:

1. The loading zone preceding the inlet barrel
2. The blast cleaning zone
3. The unloading zone following the outlet barrel

## The blast cleaning machine

The blast cleaning machine, which has a slight downward tilt in the direction of the work-piece flow, consists of various subassemblies:

- Inlet and outlet barrels
- Apron conveyor
- Abrasive circuit
- Abrasive cleaning and separation system
- Blast wheels

The inlet and outlet barrels, and the slats of the apron conveyor are provided with perforated sections for abrasive separation. The centrepiece of the blast cleaning machine is an endless apron conveyor of the kind used in batch-type drums. Supported by carrier bars, the conveyor movements ensure that the work-pieces are continuously tumbled and completely turned for thorough cleaning and removal of shot from inside areas.

## Blast cleaning of fragile castings

The execution of blast room, of inlet and outlet barrels can be adapted to meet different work-piece configurations and types including tumble-proof fragile castings.

## Consistently good cleaning results, low energy consumption, and minimal wear

Work-piece dwell-time and abrasive throughput rates are controlled by the volume of castings. This results in the best possible cleaning effect and minimal wear on machine components and abrasive. Automatic adaptation to production rate is a standard feature. The barrel rotation speed and abrasive throughput are electronically controlled, based on preprogrammed parameters.

The unique design makes it easy to integrate CT blast cleaning machines into production

lines. The picture (right page) shows a typical example of a continuous production flow, in which castings leave the moulding line and pass through the cooling and sand / castings separating systems into the blast cleaning system without any manual operation or floor transportation.

This integrated production provides the following advantages:

- Entirely automatic, continuous production flow
- Integrated cooling of castings and sand
- Recovery of moulding- and core sand during shot blasting by means of magnetic separator
- Minimal pollution through complete control and capture of dust throughout the production line right from punchout to cleaned castings

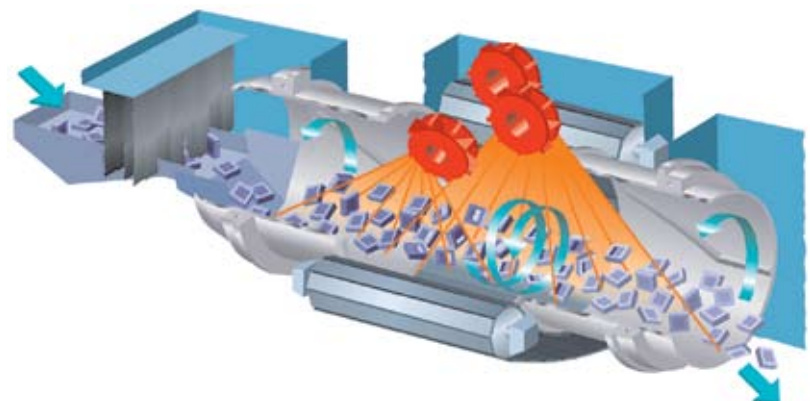

# Integration into the production line



## Unloading zone

The unloading zone with abrasive evacuation can be configured to suit customer specifications.

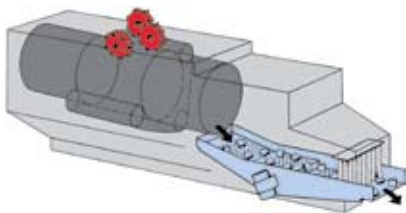

Unloading zone configuration, option 1

Stepped chute with screen sections, disposed in longitudinal direction, sealed off by integrated vestibule with curtain-type partitions.

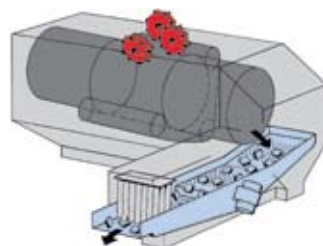

Unloading zone configuration, option 2

Stepped chute with screen sections, disposed at right angle, sealed off by integrated vestibule with curtain-type partitions.

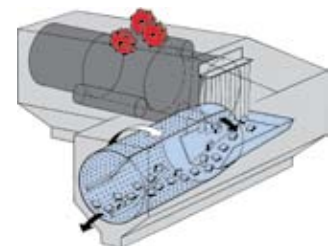

Unloading zone configuration, option 3

Perforated cylindrical drum, disposed at right angle, sealed off by double vestibule with curtain-type partitions. Excellent abrasive evacuation.

---

# Features, benefits

---



Discharge end of a CT-4 blast cleaning machine



Discharging end of a CT-4



CT-6 blast cleaning machine with noise abatement cabin and sorting belt

## Advanced work-place ecology, easy maintenance, high operation safety

With the CT Blast cleaning machine integrated into a fully automatic production line, operators do not need to touch the work-pieces until they come out of the machine – completely clean. The installation can be run without operator attendance and only requires periodic inspections.

In view of today's heavy workloads, long maintenance intervals and minimal maintenance expenses are vital. Appropriate measures ensure good wear properties and complete ease of maintenance. Simple but effective sealing elements prevent leakage of shot. An efficient dust collector and a closed-loop abrasive transport system within the machine ensure environmentally responsible operation. The unique machine structure and easily accessible service

platforms facilitate visual inspections and routine maintenance work. Safety elements make sure that access to the shot blast chamber is only possible when the machine is switched off and the blast wheels are no longer rotating.

Original wear and spare parts along with Wheelabrator service are best prerequisites to keep the blast cleaning system in perfect operating condition.

## Reconditioning of abrasive, dust collection

Clean work-pieces are reliant on clean abrasive: Sand, scale, heavy dust, fines and undersized abrasive have to be effectively removed. Taking the type and possible degree of impurities into account, Wheelabrator uses proven separation systems for this purpose:

- Magnetic separators with final pneumatic cleaning for heavily contaminated abrasive (generated in combined shot blasting, decoring, and desanding plants)
- Pneumatic separators for other applications

The dust produced is completely separated using appropriate filters. Continuous dust collection assures an efficient and environment friendly operation and perfect functioning of the abrasive separators.

# Technical Data

Max. workpiece diagonal	mm	500	900	1200	1600
Type		CT-2-30 / 5-200	CT-3-45 / 9-430	CT-4-55 / 12-430	CT-4-75 / 16-430
		CT-2-37 / 5-430	CT-4-45 / 9-430	CT-4-110 / 12-430	
		CT-4-45 / 5-430	CT-6-45 / 9-430	CT-6-110 / 12-432	
Approx. throughput rate*	t/h	3 - 14	6 - 24	18 - 30	20 - 30
Number of blast wheels		2 - 4	3 - 6	4 - 6	4
Power per blast wheel	kW	37 - 45	37 - 45 (55)	55 - 110	75
Max. sand separation	kg/min	120	200	200	450
Air required for dust collection	m <sup>3</sup> /h	10 000 - 15 000	15 000 - 30 000	22 500 - 35 000	40 000

The technical data is not binding and may be subject to change.

\* Depending on the type of parts, production method, etc  
Further machine types and measurement specification sheets upon request

- ① Inlet vibrating conveyor
- ② Blast room
- ③ Blast wheels
- ④ Abrasive circuit
- ⑤ Vibrating conveyor
- ⑥ Outlet vibrating conveyor

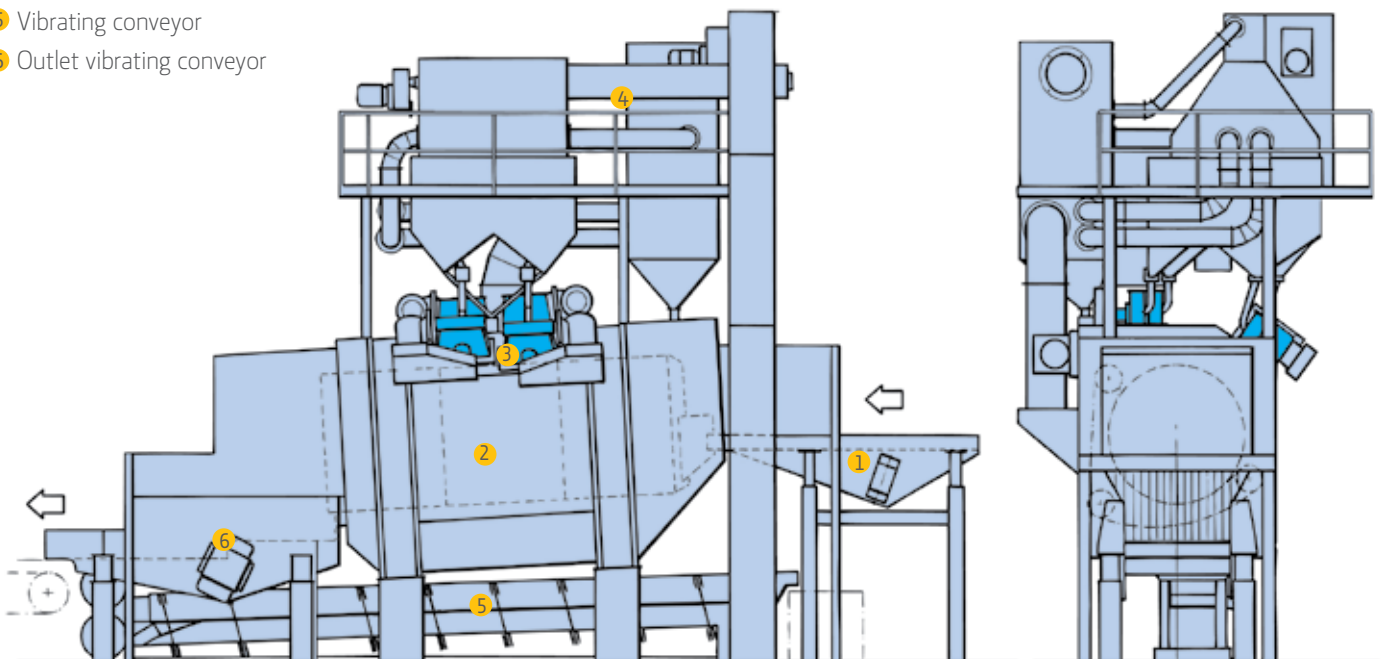

DISA Industrie AG  
Kasernenstrasse 1  
CH-8184 Bachenbülach

T: +41 44 815 4000  
F: +41 44 815 4001  
E: [zurich@wheelabratorgroup.com](mailto:zurich@wheelabratorgroup.com)  
[www.wheelabratorgroup.com](http://www.wheelabratorgroup.com)  
[www.disagroup.com](http://www.disagroup.com)

Norican Group is the parent company of DISA and Wheelabrator.

wheelabrator  
shaping industry